

YARD ROVER™ ASSEMBLY INSTRUCTIONS

Description (Qty.)

- #1 - Back Frame (2)
- #2 - Front Frame (1)
- #3 - Center Connector (1)
- #4 - Pull Handle (1)
- #5 - Axle (1)
- #6 - Poly Tray (1)
- #7 - Plastic Shim (2)
- #8 - 8x65mm Bolt (2)
- #9 - 8x45mm Bolt (6)
- #10 - 8mm Flat Washer (8)
- #11 - 8mm Lock Washer (8)
- #12 - 8mm Hex Nut (8)
- #13 - Wheel (2)
- #14 - Axle Washer (2)
- #15 - Cotter Pin (2)

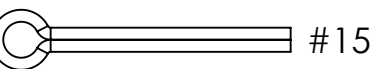
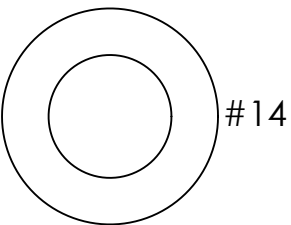
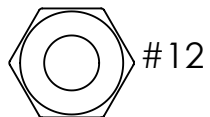
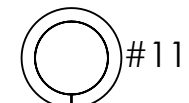
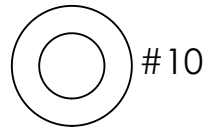
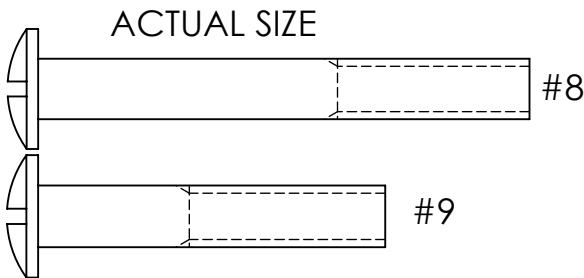
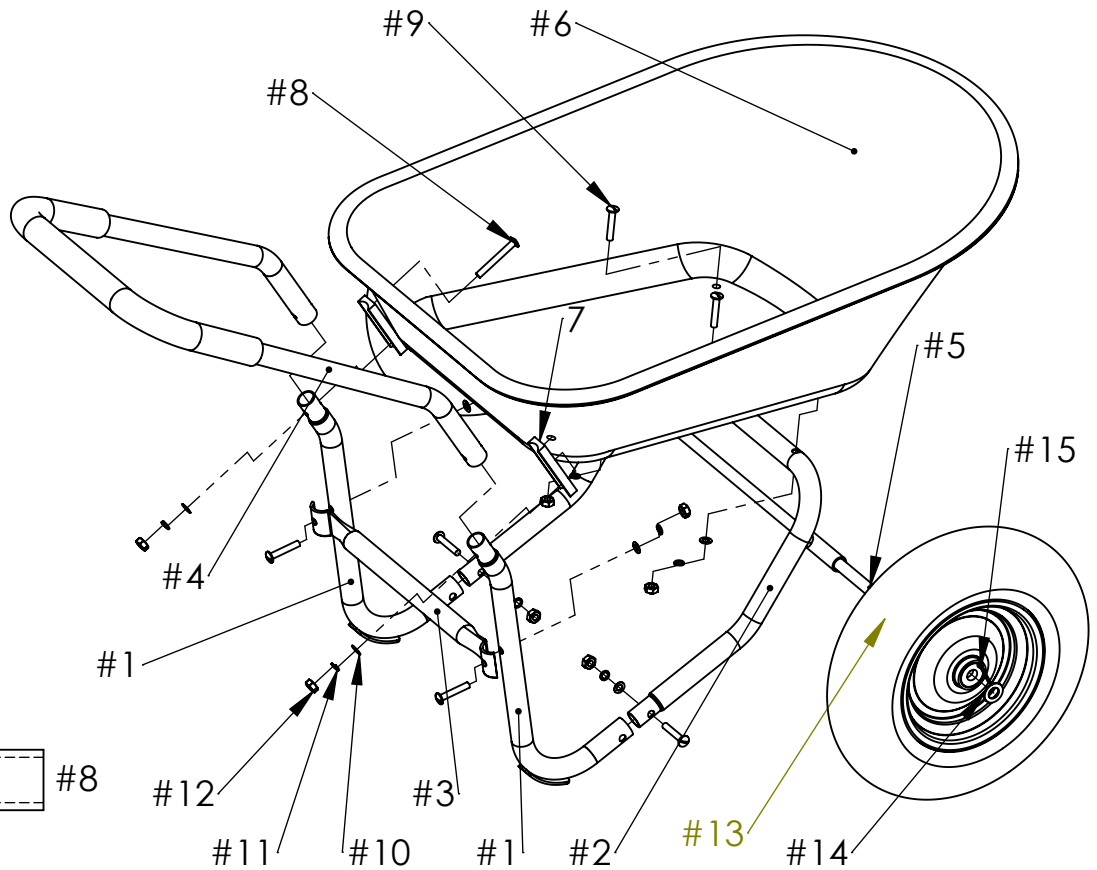

Pre-Assembly

Verify all components. Tools needed: adjustable wrench, flat screwdriver, hammer and pliers.

Assembly - (Time: 20 minutes)

1. Place the back frame (#1) tube into the front frame (#2) tube, then secure with bolt (#9), flat washer (#10), lock washer (#11) and hex nut (#12). Do not tighten. Repeat with other back frame (#1).
2. Attach center connector (#3) to both back frames (#1) with bolt (#9), flat washer (#10) lock washer (#11) and hex nut (#12). Do not tighten.
3. Insert back frame (#1) into pull handle (#4). Do Not add bolts at this time.
4. Place the poly tray (#6) onto the assembled frame. Insert bolts (#9) through the poly tray (#6) and then through the front frame (#2). Secure with flat washer (#10), lock washer (#11) and hex nut (#12). Do not tighten.
5. Place the plastic shim (#7) between the poly tray (#6) and the pull handle (#4) with the rounded side toward the handle. Insert bolt (#8) through the poly tray (#6), the lower hole in the plastic shim (#7) and the pull handle/back frame (#4/#1) hole. This may require tapping the bolt with a hammer. Secure with flat washer (#10), lock washer (#11) and hex nut (#12). Do not tighten. Repeat on the other side.
6. Tighten **ALL** bolts with the adjustable wrench and the flat screwdriver.
7. Flip the Yard Rover™ over onto the poly tray (#6) and pull handle (#4). Insert the axle (#5) through the front frame (#2).
8. Slide wheel (#13) onto the axle followed by the axle washer (#14). Insert the cotter pin (#15) through the hole in the axle (#5). Flair out cotter pin with pliers. Repeat on the other side. Your Yard Rover™ is ready for use.

**AIR TIRE
INFLATION
MAXIMUM
PRESSURE 25 PSI**

■ Marathon Industries, Inc. 1-877-425-1640 ■
visit www.marathonind.com for additional instructions